

2019年度

中学プレテスト

英語問題

(全 15 ページ)

注意事項

1. 受験番号、氏名および解答はすべて別紙の解答用紙に記入しなさい。
2. 問題用紙に解答を書きこんでも採点されません。
3. リスニング問題の放送中、問題用紙の余白にメモを取っても構いません。

* 第1問～第3問はリスニング問題です。

第1問～第3問のそれぞれで英文は2回放送されます。

(以下余白)

第1問 AとBの各問いに答えなさい。

A Aは問1と問2の2問です。それぞれの問いについて対話を聞き、その内容に合う絵として最も適切なものを、ア～エの中から一つずつ選び、記号で答えなさい。

問1 ア

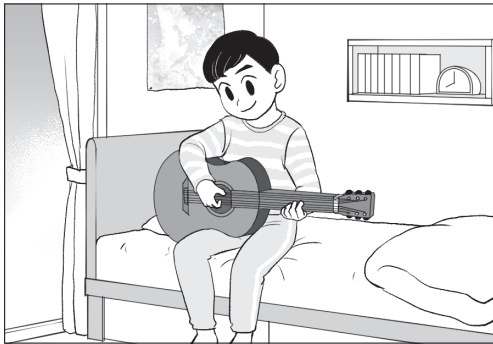

イ

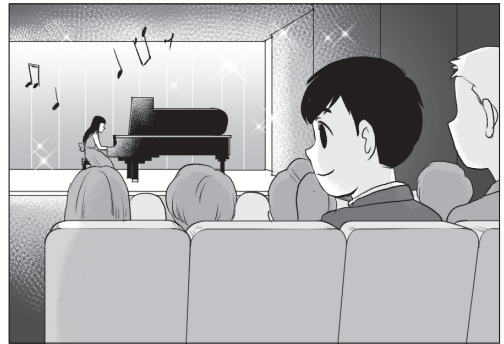

ウ



エ



問2 ア



イ

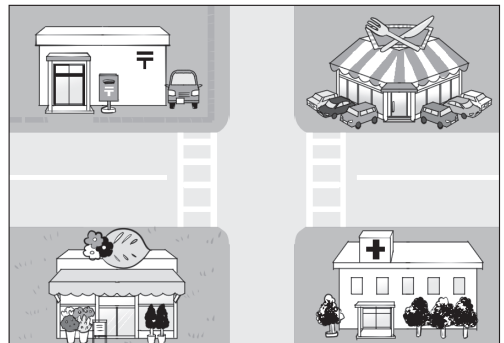

ウ



エ



B Bは問1～問3までの3問です。それぞれの問いの絵についての質問を聞き、その正しい答えとして最も適切なものを、ア～エの中から一つずつ選び、記号で答えなさい。

問1

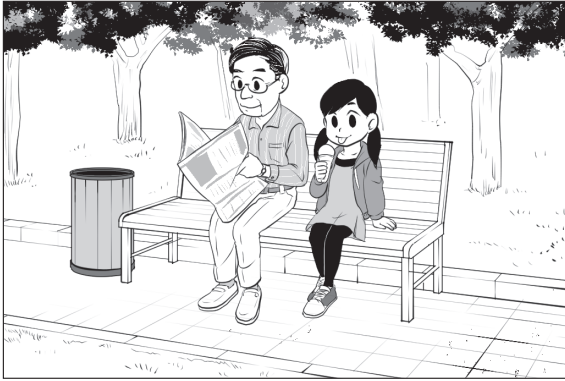

- ア Yes, he is.
- イ No, he isn't.
- ウ Yes, she is.
- エ No, she isn't.

問2

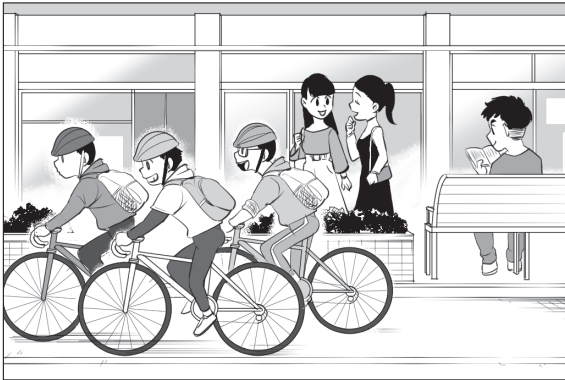

- ア Two people
- イ Three people
- ウ Five people
- エ Six people

問3

名前	出身地	行ったことがある国	行きたい国
カナ	北海道	アメリカ	カナダ
ジャック	アメリカ	オーストラリア	イギリス
ソウタ	滋賀	カナダ	アメリカ
ルーシー	オーストラリア	イギリス	中国

- ア Kana has.
- イ Jack has.
- ウ Sota has.
- エ Lucy has.

第2問 AとBの各問いに答えなさい。

A Aは問1～問3までの3問です。それぞれの問いについて対話を聞き、最後の発言に対する相手の反応として最も適切なものを、ア～エの中から一つずつ選び、記号で答えなさい。なお、^が該当の箇所^{かしよ}でベルがなります。

*最初に例題を1問放送します。

Man : Where are you from?

Woman : Moriyama, in Shiga.

Man : Do you like your city?

Woman : (the sound of bell) ベルの音が鳴ります。

ア Yes, I love it! ※ アが正答となります。

イ Yes, your city is a nice place.

ウ No. I'm from Otsu.

エ No. I have never been there.

問1

ア Yes, I can cook spaghetti.

イ Yes, I often eat it at an Italian restaurant.

ウ No, I can't find good restaurants around here.

エ No, I don't eat Japanese food at home.

問2

ア I'm going to leave Japan on December 25th.

イ It's my first time to go to Australia.

ウ I'm going to see koalas and kangaroos.

エ I can't decide what to buy there.

問3

ア It's not so important to listen to the words.

イ We have English tests twice a week.

ウ English is more difficult than Japanese.

エ Read the words aloud when you write them.

B Bは問1～問3までの3問です。それぞれの対話とその内容についての質問を聞き、その正しい答えとして最も適切なものを、ア～エの中から一つずつ選び、記号で答えなさい。

問1

- ア At a stadium
- イ At an airport
- ウ At a station
- エ At a museum

問2

- ア They are going to have a party for him.
- イ They are going to eat pancakes with Kota at Yuto's house.
- ウ They are going to go to Tokyo with him to eat pancakes.
- エ They are going to join a party to say goodbye to Mary.

問3

- ア To play computer games.
- イ To fix the computer.
- ウ To buy a new computer.
- エ To take the computer to the living room.

第3問 ある生徒が、5枚の写真を使いながら英語でスピーチをしています。生徒は、最初の写真に続けて、ほかの写真をどのような順番で見せたのでしょうか。正しい順番となるように写真を並べかえ、記号で答えなさい。ただし、ア～オの中には不要な写真が1枚含まれています。

最初の写真

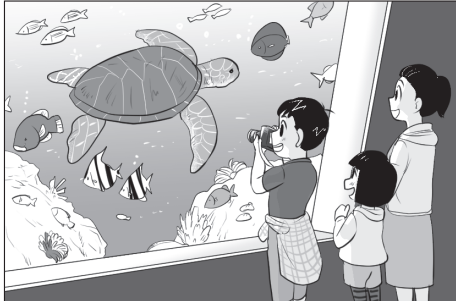

ア

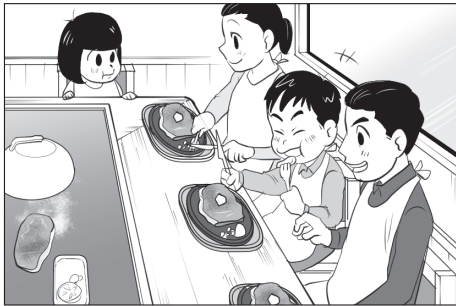

イ

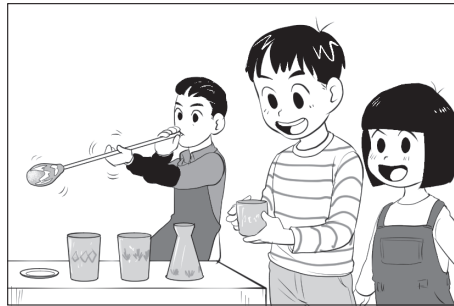

ウ

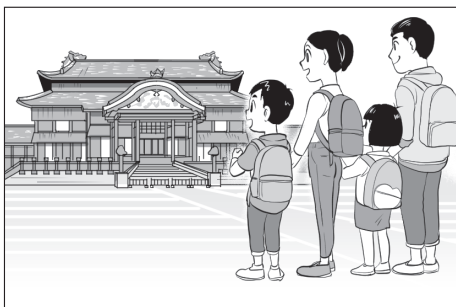

エ

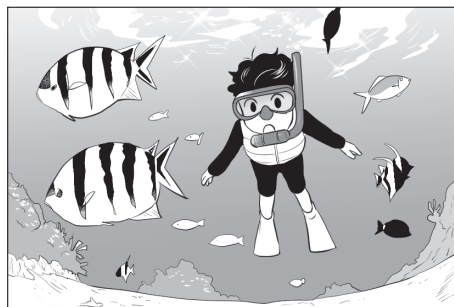

オ

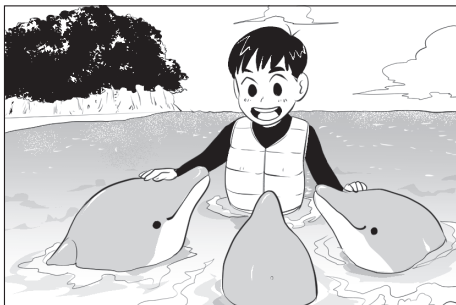

次のページから筆記問題が始まります。

第4問

問1 次の1～4の英文の()内に入る語句として最も適切なものを、下のア～エの中から一つずつ選び、記号で答えなさい。

1. Ms. White () in Japan since she was fifteen.

ア has lived イ lived ウ is living エ will live

2. I was () to Amy by my sister yesterday.

ア remembered イ saved ウ invited エ introduced

3. My father is brave and kind. I am really () of him.

ア pleased イ proud ウ famous エ surprised

4. There are some children () soccer in the park.

ア play イ plays ウ playing エ played

問2 次の1と2については英文の()内に入る語として最も適切なものを、3と4については、英文の最後の質問に対する答えとして最も適切なものを、下のア～エの中から一つずつ選び、記号で答えなさい。

1. When we go out on a cold winter day, we need (). We can keep our hands warm with them.

ア socks

イ gloves

ウ boots

エ glasses

2. My dream is to be an (). I want to travel into space and see the earth from space.

ア engineer

イ artist

ウ astronaut

エ actor

3. I went to a shop with 1,500 yen. I bought three pens and five notebooks. I have 800 yen now, each notebook was 80 yen. How much was each pen?

ア



イ

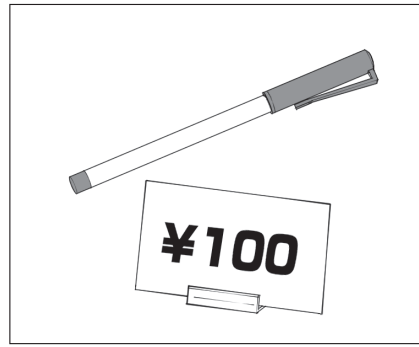

ウ



エ

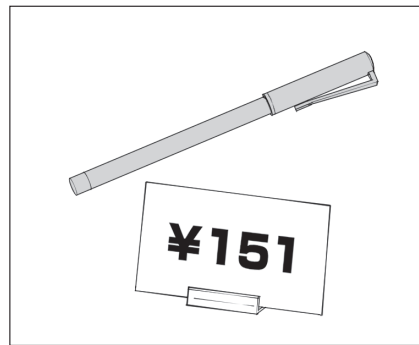

4. I'm drawing a picture of a garden. I can see many flowers and two chairs. What will the picture be like?

ア

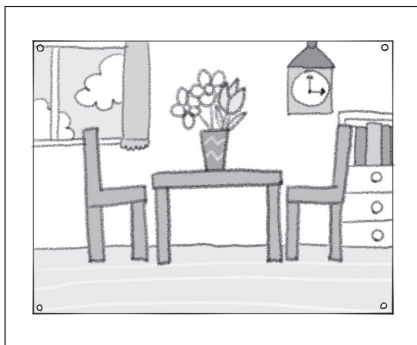

イ

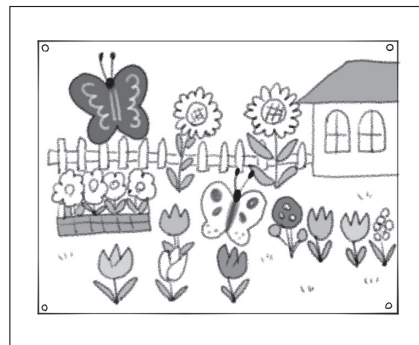

ウ

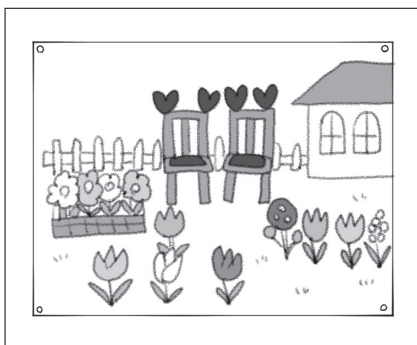

エ

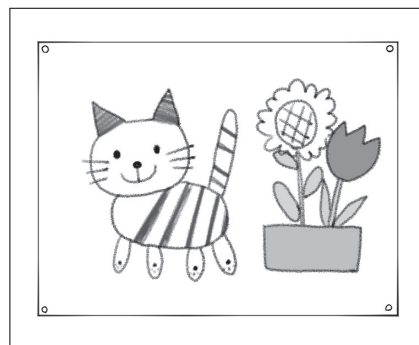

第5問

問1 次の1～3の対話文の()内に入る英文として、最も適切なものを、下のア～エの中から一つずつ選び、記号で答えなさい。

1. A : Good morning. ()

B : I'm William Lewis.

ア Could you tell me his name?

イ May I have your name, please?

ウ Did you have a good time here?

エ How are you doing?

2. A : It's raining! I must buy an umbrella.

B : () Let's use mine together.

A : Oh, really? Thank you very much.

ア Please lend me yours.

イ You have a lot of umbrellas.

ウ You don't have to.

エ Please bring your umbrella.

3. A : Are you ready to go, Sarah?

B : No, not yet! () I have no idea.

A : I think those black ones are good. Let's go!

ア Which shoes should I wear?

イ When does the party start?

ウ Where is my black coat?

エ How much are those shoes?

問2 次の1～3の対話文の(a), (b)内に入る英文として最も適切なものを, それぞれア～エの中から一つずつ選び, 記号で答えなさい。

1. A : How did you like the movie?

B : (a)

A : Really? Why do you think so?

B : I love the story and the music of the movie. How about you?

A : (b)

B : OK, then, let's see an action movie next time.

Ⓐ ア I didn't like it so much.

イ It was really interesting.

ウ It was black and white.

エ It was very long.

Ⓑ Ⓐ I like more exciting movies.

イ I like science better than music.

ウ You can play the piano well.

エ I want to see it again.

2. A : Mom's birthday is next week.

B : (a)

A : I'm going to cook dinner.

B : Shall I help you?

A : (b)

B : I see. Do your best. Then, I will buy a new bag for her.

Ⓐ Ⓐ What are you going to do for her?

イ Does your mother like cooking?

ウ How old is your mother?

エ When is her birthday?

Ⓑ Ⓐ I'm sorry, but she can cook better than you.

イ That's a good idea. She will be glad.

ウ OK. Let's cook her favorite dishes.

エ Thank you, but I want to do it by myself.

3. A : Hello, this is Yuki. Can I talk to Jim?

B : I'm sorry. He's out now.

A : Oh, OK. (a)

B : I think he will be back around 6:00 p.m.

A : (b)

Ⓐ Ⓐ Where is he going to go?

イ Can I take a message?

ウ When will he be back?

エ Will he come to my house?

Ⓑ Ⓐ I can meet him at noon.

イ I'll call again, then.

ウ I know his phone number.

エ Just a moment, please.

第6問 次の広告をよく読んで、以下の問いに答えなさい。

A robot festival!

Are you interested in robots? We have a special event to make robots!

PLACE : Room A at Oak Science and Technology Museum
DATE & TIME : December 7th, 8th | 2:00 p.m. ~ 2:00 p.m.

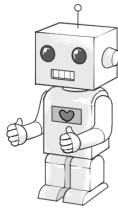

This robot can stand up and sit down.
It can even run and dance!
You can choose a red robot or a blue robot.
It's a great robot, and it's easy to make it.

TEACHER : Mr. Brown (science teacher at Oak Junior High School)



I love robots. Making robots is fun!
Let's enjoy it together!

- ☆ Fee : \$10 for a person *\$5 for a child under thirteen years old
- ☆ Please bring an old T-shirt. It may get dirty when you paint a robot.
- ☆ If you want to join this event, please call 07X-XXX-XXXX or send an e-mail to xxxxx@xxx.com.

問1 広告の内容に合うように、次の文の()内に入る語句として最も適切なものを、下のア～エの中から一つ選び、記号で答えなさい。

When you join the event, you should go to ().

- ア Mr. Brown's house
- イ Oak Science and Technology Museum
- ウ Oak Junior High School
- エ A robot shop

問2 広告の内容に合うように、次の1, 2の質問に対する答えとして最も適切なものを、下のア～エの中から一つずつ選び、記号で答えなさい。

1. What can you do at the event?

- ア Play with a robot
- イ Run and dance
- ウ Learn how to use a computer
- エ Make a robot

2. Which is true about the event?

- ア An elementary school student will pay \$10 to join it.
- イ People can buy a new T-shirt.
- ウ People should call or send an e-mail to join it.
- エ The robot is difficult to make.

第7問 次の英文をよく読んで、以下の問いに答えなさい。

The fourth Thursday in November is a special day for American people. The day is called “Thanksgiving Day.” It is a day to say “Thank you” for all the food: vegetables, fruits, and meats. People don’t have work or school that day. They enjoy a big meal with their family or friends.

On Thanksgiving Day, most shops and restaurants are closed because it is common to eat traditional dishes at home. People cook turkey, pumpkin soup, corn bread, pumpkin pies, sweet potatoes, and so on. People also put orange, yellow, or red flowers on the table. You can see a lot of colors of autumn on the table.

The day after Thanksgiving Day, people usually go out and enjoy shopping because a lot of shops start big winter sales. For example, people buy clothes, TVs, or computers. Parents buy toys for their children. For a lot of American parents, this day is good for preparing Christmas presents.

本文の内容に合うように、次の問1～問3の質問に対する答えとして最も適切なものを、下のア～エの中から一つずつ選び、記号で答えなさい。

問1 What is Thanksgiving Day for American people?

- ア It is a day to enjoy a lot of shopping.
- イ It is a day to go to school with their family.
- ウ It is a day to give thanks for all the food.
- エ It is a day to prepare Christmas presents.

問2 Thanksgiving Day の食事の様子として書かれていることは次のうちのどれですか。

ア

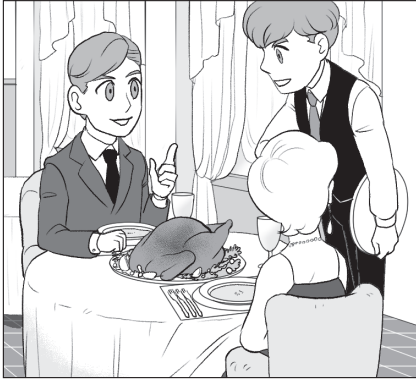

イ

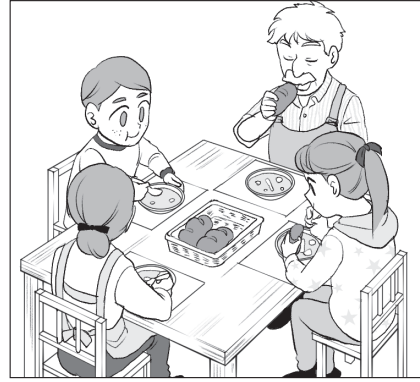

ウ

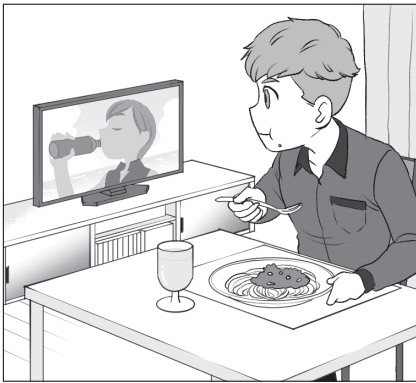

エ

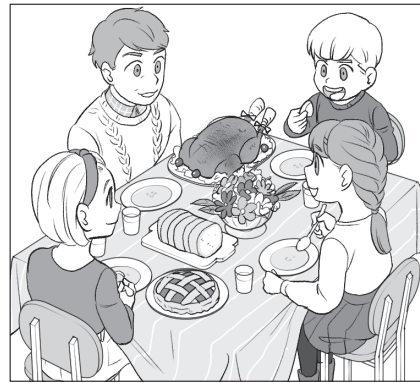

問3 Thanksgiving Day の次の日の様子として書かれていることは次のうちのどれですか。

ア



イ



ウ



エ



これで筆記問題は終わりです。

